



OBSTACLE 1

1 Obstacle «CREDIT MUTUEL»



Distodgeable elements
3 ★

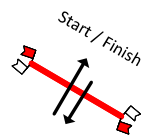
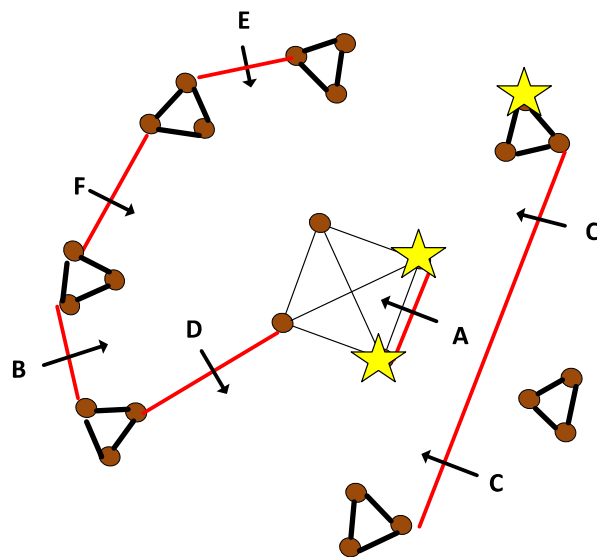



OBSTACLE 2

2 Obstacle «BIVB»



B
BOURGOGNE

Distodgeable elements
7 ★

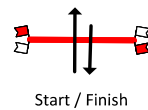
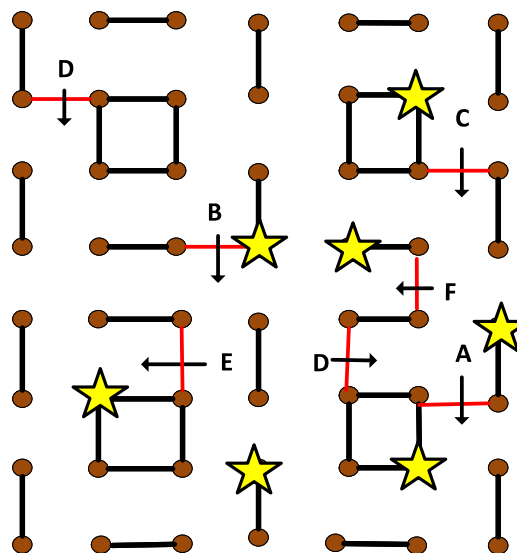



OBSTACLE 3

3 Obstacle «HOSTELLERIE DES CLOS»



Dislodgeable elements
4 ★

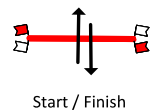
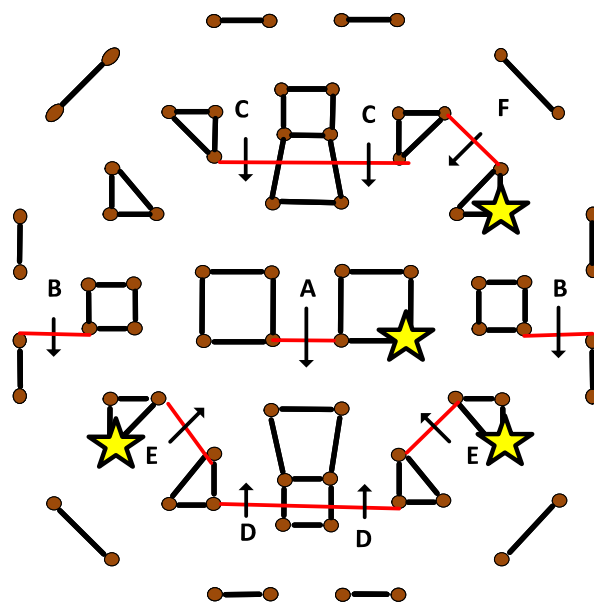



OBSTACLE 4

4 Obstacle « REGION BOURGOGNE France COMTE »



**REGION
BOURGOGNE
FRANCHE
COMTE**

Distodgeable elements
2 ★

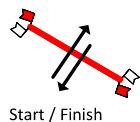
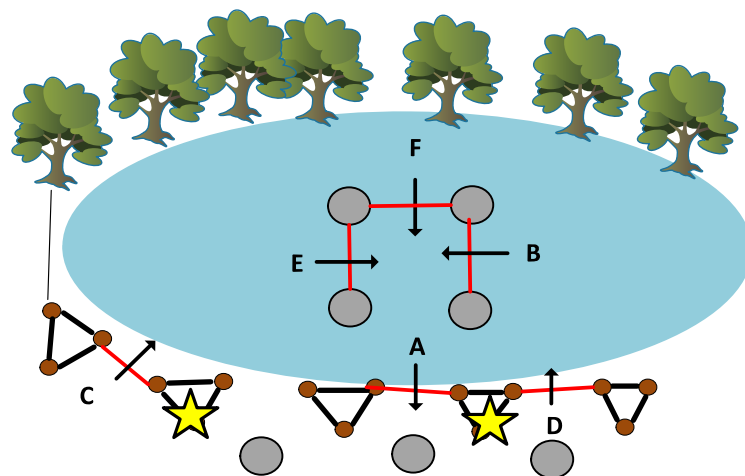

Start / Finish





OBSTACLE 5

5 Obstacle « HIPPOCCAZ »



Distodgeable elements
2 ★

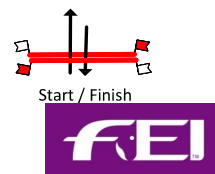
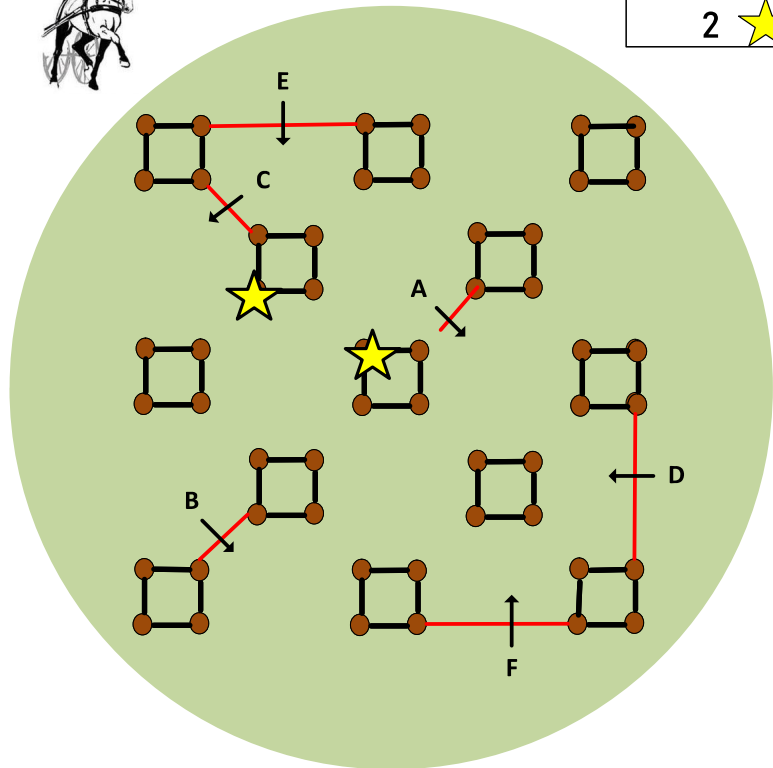



OBSTACLE 6

6 Obstacle « KESTRYAN »



Distodgeable
elements
3 ★

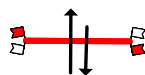
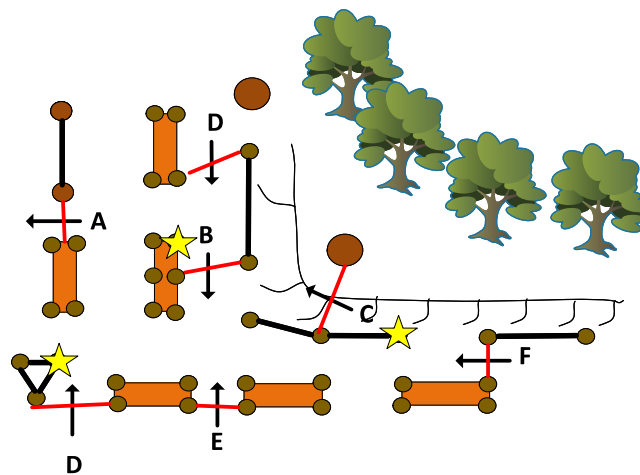

Start / Finish





OBSTACLE 7

7 Obstacle « DEPARTEMENT DU YONNE »



Distodgeable elements
★ 15

